

Users' Guide



KINGWIN

www.kingwin.com

KF-series

EIDE Mobile Racks

- ★ **The only Cool Thermal Solution**
- ★ **Easy Installation**
- ★ **Protection for High-Quality Data Storage & Transmission**
- ★ **Warranty Provided**

Quality

Speed

Flexibility

Value

Installation Guide

for KF21 / KF22 / KF23 Models

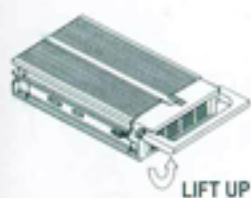

Fg.1
Take out the Inner Tray

Lift up the handle 90 degrees. The inner tray will come out automatically.



Fg.2
Take off the Top Cover

Bend the Top Cover Hook with a little force & slide the Top Cover to the rear of the Inner Tray to open it.

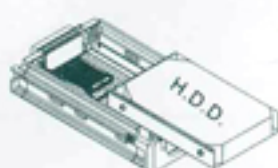

Fg.3
Connect the Cable & Code

Connect the Data Cable & Power Code of the Inner Tray to the H.D.D. (Please connect them correctly to avoid electrical damage.)

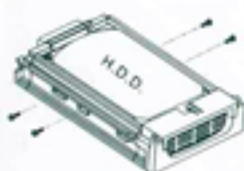

Fg.4
Screw the H.D.D. on

Put the H.D.D. in the Inner Tray and screw it on tightly.

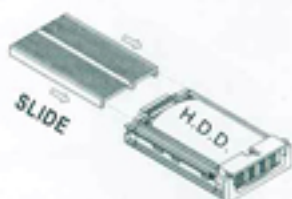

Fg.5
Close the Top Cover

Slide the Top Cover along the Cover-Rails to the front end of the Inner Tray until it been hooked by the Top Cover Hook.

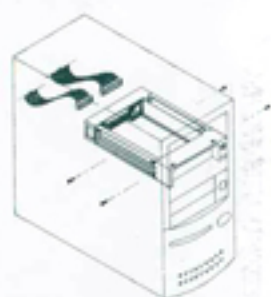

Fg.6
Screw the Outer Frame on

Put the Outer Frame in the 5.25" drive bay of the PC case and connect the Data Cable & Power Code to the Outer Frame. Then, screw the Outer Frame to the PC case. (Please connect them correctly to avoid electrical damage.)

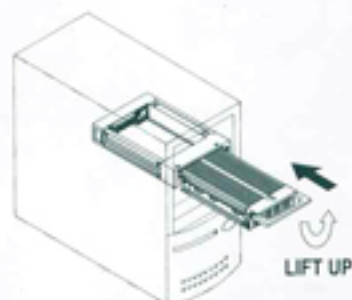

Fg.7
Plug in the Inner Tray

Lift up the Handle 90 degrees and push the inner tray into the installed Outer Frame until it stops.

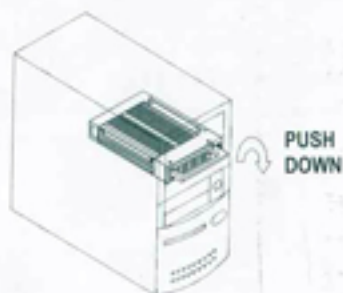

Fg.8
Lock the Inner Tray

Push the Handle down with little force, and the Inner Tray will be automatically plugged into the correct position. Insert the enclosed key into the lock hole, push and turn it right to lock the Inner Tray. Then, you will have completed the installation.

Installation Guide

for KF20 Models



Fig.1
Take out the Inner Tray

Lift up the handle 90 degrees. The inner tray will come out automatically.

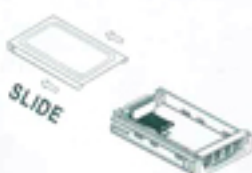

Fig.2
Take off the Top Cover

Push the Top Cover with force to the rear of the Inner Tray to open it.

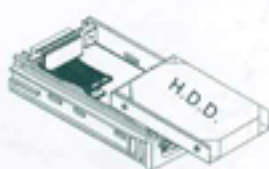

Fig.3
Connect the Cable & Code

Connect the Data Cable & Power Code of the Inner Tray to the H.D.D. (Please connect them correctly to avoid electrical damage.)



Fig.4
Screw the H.D.D. on

Put the H.D.D. in the Inner Tray and screw it on tightly.

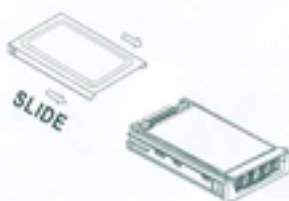

Fig.5
Close the Top Cover

Slide the Top Cover along the Cover-Rails to the front end of the Inner Tray. Then you will hear a crisp clicking sound indicating that you have closed the Top Cover.

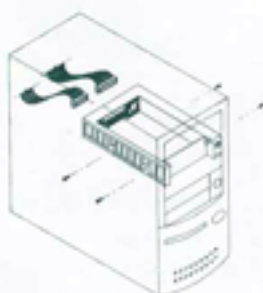

Fig.6
Screw the Outer Frame on

Put the Outer Frame in the 5.25" drive bay of the PC case and connect the Data Cable & Power Code to the Outer Frame. Then, screw the Outer Frame to the PC case. (Please connect them correctly to avoid electrical damage.)

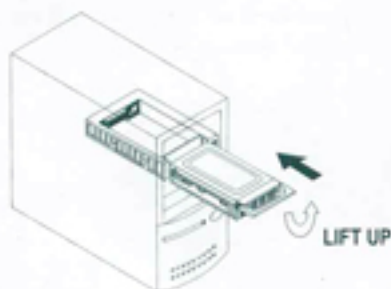

Fig.7
Plug in the Inner Tray

Lift up the Handle 90 degrees and push the inner tray into the installed Outer Frame until it stops.

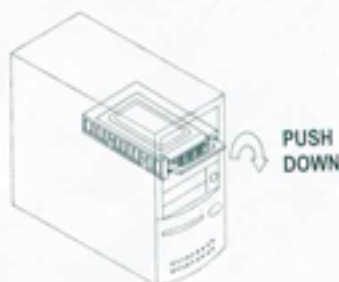

Fig.8
Lock the Inner Tray

Push the Handle down with little force, and the Inner Tray will be automatically plugged into the correct position. Insert the enclosed key into the lock hole, push and turn it right to lock the Inner Tray. Then, you will have completed the installation.

Multiple Applications: Guide to install MO, ZIP, LS-120, TR-4 Tape Drive, Flash Card Reader, etc.

(for KF21 / KF22 / KF23 Models)

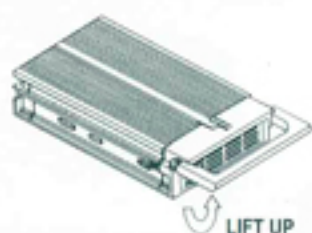

Fig.1
Take out the Inner Tray

Lift up the handle 90 degrees. The inner tray will come out automatically.

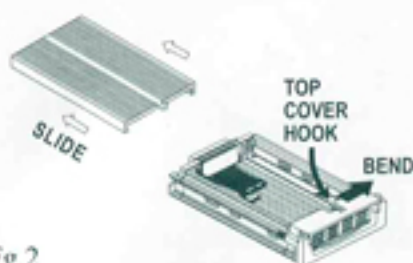

Fig.2
Take off the Top Cover

Bend the Top Cover Hook with a little force & slide the Top Cover to the rear of the Inner Tray to open it.

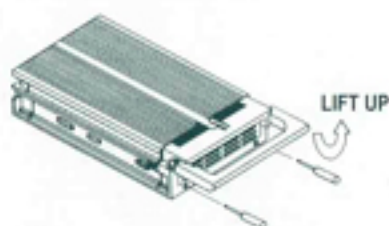

Fig.3
Take out the Screws

Lift up the Handle 90 Degrees. Use a screwdriver to take out the screws that fasten the Fan(s).



Fig.4
Take out the Fan(s)

Pull the fan wire lightly away from the power extension. Then take out the fan(s).

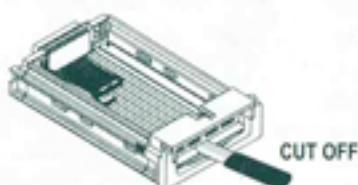

Fig.5
Take off the Front Panel

To take off the front panel of the Inner Tray, please use a knife to cut it off.

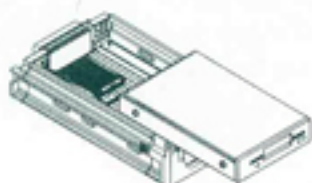

Fig.6
Connect the Cable & Code

Connect the Data Cable & Power Code of the Inner Tray to the device. (Please connect them correctly to avoid the electrical damage.)

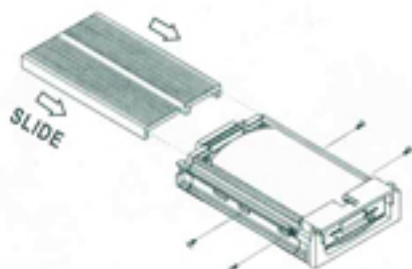

Fig.7
Screw the Storage Device on

Put the device in the Inner Tray and screw it on firmly with the enclosed M6x6 HDD screws or M3x5 of device screws.

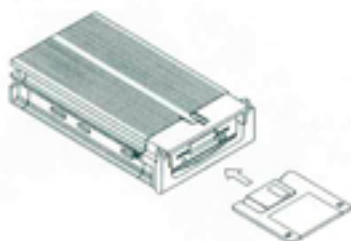

Fig.8
Close the Top Cover

Slide the Top Cover along the Cover-Rails to the front end of the Inner Tray. Then push down the Top Cover Hook lightly to close the Top Cover. Now, you have completed the installation.

Recommended Method of Fan-Cleaning

Do not use erosive, flammable solution or water to clean a fan, as either will cause rusting on the metal parts and the electronic components, and will wash out the lubricants that the fan will require for normal operating.

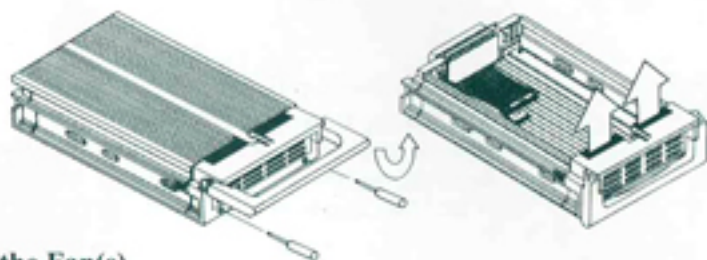

Fig.1
Take out the Fan(s).

Pull out the fan from the power extension. Please follow the method as described on page 3.

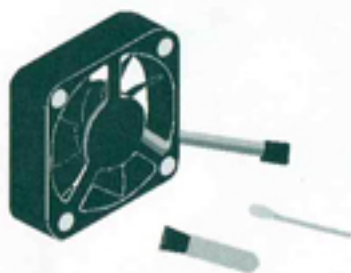

Fig.2
Clean the Fan(s).

Use a cotton stick to clean the dust on the fan blades. Then, use a small brush to clean the whole fan thoroughly.

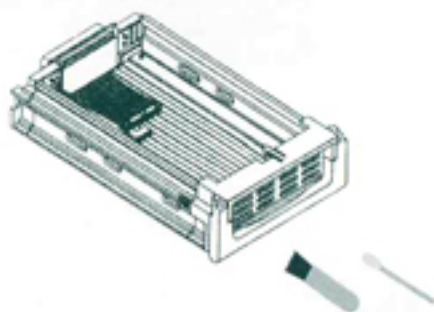

Fig.3
Clean the Inner Tray.

Use a cotton stick and a brush to clean both sides of the front panel of the inner tray. Then, use a dry cloth or tissue to clean the interior of the inner tray.

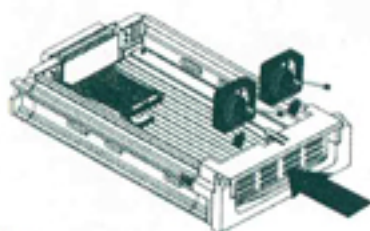

Fig.4
Install the Cleaned Fan(s)

Connect the fan to the power extension and install the fan. Please note that only when the fan draws air in from outside, will the fan be correctly installed. Otherwise, you must reverse the direction of the wrongly installed fan to avoid a great loss in thermal efficiency.

Three Rules to follow to keep high-quality data transmission

Rule 1. Always keep the connectors of the inner tray closely in contact with those of the outer frame.

■ **The handle of the inner tray should be kept in an upright position relative to the top face of the inner tray.**

Before starting your PC, make sure that the outward face of the handle is even with the front face of the outer frame. When this is done, the inner tray has been closely set in the outer frame. In case the handle is somehow not aligned with the front face (that is, not in a completely upright position), push it forward with a little force until it is completely aligned (that is, the angle is set at zero degrees). Then the inner tray will have been set in the outer frame, and the data-transmission quality will thus be assured.



■ **Lock the security lock**

Before using any mobile rack, remember to insert the key enclosed in the accessory bag into the security lock, and press lightly and turn it right. The inner tray will then be locked in and can't be drawn out. (Note: if you are using a model with a power lock, you must complete this step to turn on the storage device inside the inner tray. Unless you have done this, the storage device won't operate at all because there won't be any power supply.)

Rule 2. Electrical shutdown is prohibited.

When the storage device is at work, i.e., when it is reading or writing data, inappropriate shutdown of your PC or pull-out of the inner tray is prohibited. Otherwise, the storage device as well as the data in it may be damaged.

While your PC system is ON, do not try to pull out the Inner Tray.



Rule 3. Keep your storage device working in a cool environment.

Over time, dust will accumulate on the fan blades causing the fan to malfunction. The fan may even stop running completely. It is therefore recommended that you clean the fan(s), front panel, and interior of the inner tray every 2-4 months, depending on where you live. Cleaning the fan(s) regularly so it (they) can run normally will help maintain the maximum thermal efficiency that the design of our mobile racks affords, and will consequently lengthen the useful lives of the storage device and the fan itself.